

LMH6639

190MHz Rail-to-Rail Output Amplifier with Disable

General Description

The LMH6639 is a voltage feedback operational amplifier with a rail-to-rail output drive capability of 110mA. Employing National's patented VIP10 process, the LMH6639 delivers a bandwidth of 190MHz at a current consumption of only 3.6mA. An input common mode voltage range extending to 0.2V below the V^- and to within 1V of V^+ , makes the LMH6639 a true single supply op-amp. The output voltage range extends to within 30mV of either supply rail providing the user with a dynamic range that is especially desirable in low voltage applications.

The LMH6639 offers a slew rate of 172V/ μ s resulting in a full power bandwidth of approximately 28MHz. The T_{ON} value of 83nsec combined with a settling time of 33nsec makes this device ideally suited for multiplexing applications. Careful attention has been paid to ensure device stability under all operating voltages and modes. The result is a very well behaved frequency response characteristic for any gain setting including +1, and excellent specifications for driving video cables including harmonic distortion of -60dBc, differential gain of 0.12% and differential phase of 0.045°

Features

($V_S = 5V$, Typical values unless specified)

| | |
|---|-----------------|
| ■ Supply current (no load) | 3.6mA |
| ■ Supply current (off mode) | 400 μ A |
| ■ Output resistance (closed loop 1MHz) | 0.186 Ω |
| ■ -3dB BW ($A_V = 1$) | 190MHz |
| ■ Settling time | 33nsec |
| ■ Input common mode voltage | -0.2V to 4V |
| ■ Output voltage swing | 40mV from rails |
| ■ Linear output current | 110mA |
| ■ Total harmonic distortion | -60dBc |
| ■ Fully characterized for 3V, 5V and $\pm 5V$ | |
| ■ No output phase reversal with CMVR exceeded | |
| ■ Excellent overdrive recovery | |
| ■ Off Isolation 1MHz | -70dB |
| ■ Differential Gain | 0.12% |
| ■ Differential Phase | 0.045° |

Applications

- Active filters
- CD/DVD ROM
- ADC buffer amplifier
- Portable video
- Current sense buffer

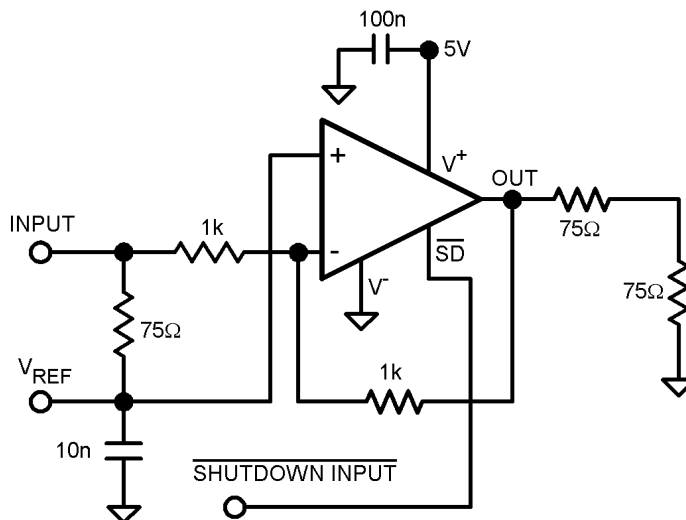

20030246

FIGURE 1. Typical Single Supply Schematic

Absolute Maximum Ratings (Note 1)

If Military/Aerospace specified devices are required, please contact the National Semiconductor Sales Office/Distributors for availability and specifications.

| | |
|--------------------------------|---------------------------------|
| ESD Tolerance | 2KV (Note 2) |
| | 200V (Note 9) |
| V_{IN} Differential | $\pm 2.5V$ |
| Input Current | $\pm 10mA$ |
| Supply Voltage ($V^+ - V^-$) | 13.5V |
| Voltage at Input/Output pins | $V^+ + 0.8V, V^- - 0.8V$ |
| Storage Temperature Range | $-65^\circ C$ to $+150^\circ C$ |
| Junction Temperature (Note 4) | $+150^\circ C$ |

Soldering Information

| | |
|---------------------------------|---------------|
| Infrared or Convection (20 sec) | $235^\circ C$ |
| Wave Soldering (10 sec) | $260^\circ C$ |

Operating Ratings (Note 1)

| | |
|---|--------------------------------|
| Supply Voltage ($V^+ - V^-$) | 3V to 12V |
| Operating Temperature Range (Note 4) | $-40^\circ C$ to $+85^\circ C$ |
| Package Thermal Resistance (θ_{JA}) (Note 4) | |
| SOT23-6 | $265^\circ C/W$ |
| SOIC-8 | $190^\circ C/W$ |

3V Electrical Characteristics

Unless otherwise specified, all limits guaranteed for at $T_J = 25^\circ C$, $V^+ = 3V$, $V^- = 0V$, $V_O = V_{CM} = V^+/2$, and $R_L = 2k\Omega$ to $V^+/2$. **Boldface** limits apply at the temperature extremes.

| Symbol | Parameter | Conditions | Min (Note 6) | Typ (Note 5) | Max (Note 6) | Units |
|--------------|---------------------------------|--|-----------------|-----------------|-----------------|------------------|
| BW | -3dB BW | $A_V = +1$ | 120 | 170 | | MHz |
| | | $A_V = -1$ | | 63 | | |
| $BW_{0.1dB}$ | 0.1dB Gain Flatness | $R_F = 2.65k\Omega$, $R_L = 1k\Omega$, | | 16.4 | | MHz |
| FPBW | Full Power Bandwidth | $A_V = +1$, $V_{OUT} = 2V_{PP}$, -1dB $V^+ = 1.8V$, $V^- = 1.2V$ | | 21 | | MHz |
| GBW | Gain Bandwidth product | $A_V = +1$ | | 83 | | MHz |
| e_n | Input-Referred Voltage Noise | $R_F = 33k\Omega$ | $f = 10kHz$ | 19 | | nV/\sqrt{Hz} |
| | | | $f = 1MHz$ | 16 | | |
| i_n | Input-Referred Current Noise | $R_F = 1M\Omega$ | $f = 10kHz$ | 1.30 | | pA/\sqrt{Hz} |
| | | | $f = 1MHz$ | 0.36 | | |
| THD | Total Harmonic Distortion | $f = 5MHz$, $V_O = 2V_{PP}$, $A_V = +2$, $R_L = 1k\Omega$ to $V^+/2$ | | -50 | | dBc |
| T_S | Settling Time | $V_O = 2V_{PP}$, $\pm 0.1\%$ | | 37 | | ns |
| SR | Slew Rate | $A_V = -1$ (Note 8) | 120 | 167 | | V/ μs |
| V_{OS} | Input Offset Voltage | | | 1.01 | 5 7 | mV |
| TC V_{OS} | Input Offset Average Drift | (Note 11) | | 8 | | $\mu V/^\circ C$ |
| I_B | Input Bias Current | (Note 7) | | -1.02 | -2.6 -3.5 | μA |
| I_{OS} | Input Offset Current | | | 20 | 800 1000 | nA |
| R_{IN} | Common Mode Input Resistance | $A_V = +1$, $f = 1kHz$, $R_S = 1M\Omega$ | | 6.1 | | M Ω |
| C_{IN} | Common Mode Input Capacitance | $A_V = +1$, $R_S = 100k\Omega$ | | 1.35 | | pF |
| CMVR | Input Common-Mode Voltage Range | CMRR $\geq 50dB$ | | -0.3 | -0.2 -0.1 | V |
| | | | 1.8 1.6 | 2 | | |
| CMRR | Common Mode Rejection Ratio | (Note 12) | 72 | 93 | | dB |
| A_{VOL} | Large Signal Voltage Gain | $V_O = 2V_{PP}$, $R_L = 2k\Omega$ to $V^+/2$ | 80 76 | 100 | | dB |
| | | $V_O = 2V_{PP}$, $R_L = 150\Omega$ to $V^+/2$ | 74 70 | 78 | | |

3V Electrical Characteristics (Continued)

Unless otherwise specified, all limits guaranteed for at $T_J = 25^\circ\text{C}$, $V^+ = 3\text{V}$, $V^- = 0\text{V}$, $V_O = V_{\text{CM}} = V^+/2$, and $R_L = 2\text{k}\Omega$ to $V^+/2$. **Boldface** limits apply at the temperature extremes.

| Symbol | Parameter | Conditions | Min (Note 6) | Typ (Note 5) | Max (Note 6) | Units |
|---------------------|-------------------------------------|--|-----------------|-----------------|-------------------|---------------|
| V_O | Output Swing High | $R_L = 2\text{k}\Omega$ to $V^+/2$, $V_{\text{ID}} = 200\text{mV}$ | 2.90 | 2.98 | | V |
| | | $R_L = 150\Omega$ to $V^+/2$, $V_{\text{ID}} = 200\text{mV}$ | 2.75 | 2.93 | | |
| | | $R_L = 50\Omega$ to $V^+/2$, $V_{\text{ID}} = 200\text{mV}$ | 2.6 | 2.85 | | |
| | Output Swing Low | $R_L = 2\text{k}\Omega$ to $V^+/2$, $V_{\text{ID}} = -200\text{mV}$ | | 25 | 75 | mV |
| | | $R_L = 150\Omega$ to $V^+/2$, $V_{\text{ID}} = -200\text{mV}$ | | 75 | 200 | |
| | | $R_L = 50\Omega$ to $V^+/2$, $V_{\text{ID}} = -200\text{mV}$ | | 130 | 300 | |
| I_{SC} | Output Short Circuit Current | Sourcing to $V^+/2$, (Note 10) | 50 35 | 120 | | mA |
| | | Sinking to $V^+/2$, (Note 10) | 67 40 | 140 | | |
| I_{OUT} | Output Current | $V_O = 0.5\text{V}$ from either supply | | 99 | | mA |
| PSRR | Power Supply Rejection Ratio | (Note 12) | 72 | 96 | | dB |
| I_S | Supply Current (Enabled) | No Load | | 3.5 | 5.6 7.5 | mA |
| | Supply Current (Disabled) | | | 0.3 | 0.5 0.7 | |
| TH_SD | Threshold Voltage for Shutdown Mode | | | $V^+ - 1.59$ | | V |
| $I_{\text{SD PIN}}$ | Shutdown Pin Input Current | SD Pin Connect to 0V (Note 7) | | -13 | | μA |
| T_{ON} | On Time After Shutdown | | | 83 | | nsec |
| T_{OFF} | Off Time to Shutdown | | | 160 | | nsec |
| R_{OUT} | Output Resistance Closed Loop | $R_F = 10\text{k}\Omega$, $f = 1\text{kHz}$, $A_V = -1$ | | 27 | | m Ω |
| | | $R_F = 10\text{k}\Omega$, $f = 1\text{MHz}$, $A_V = -1$ | | 266 | | |

5V Electrical Characteristics

Unless otherwise specified, all limits guaranteed for at $T_J = 25^\circ\text{C}$, $V^+ = 5\text{V}$, $V^- = 0\text{V}$, $V_O = V_{\text{CM}} = V^+/2$, and $R_L = 2\text{k}\Omega$ to $V^+/2$. **Boldface** limits apply at the temperature extremes.

| Symbol | Parameter | Conditions | Min (Note 6) | Typ (Note 5) | Max (Note 6) | Units |
|---------------------|------------------------------|---|--------------------|-----------------|-----------------|------------------------|
| BW | -3dB BW | $A_V = +1$ | 130 | 190 | | MHz |
| | | $A_V = -1$ | | 64 | | |
| $BW_{0.1\text{dB}}$ | 0.1dB Gain Flatness | $R_F = 2.51\text{k}\Omega$, $R_L = 1\text{k}\Omega$, | | 16.4 | | MHz |
| FPBW | Full Power Bandwidth | $A_V = +1$, $V_{\text{OUT}} = 2V_{\text{PP}}$, -1dB | | 28 | | MHz |
| GBW | Gain Bandwidth Product | $A_V = +1$ | | 86 | | MHz |
| e_n | Input-Referred Voltage Noise | $R_F = 33\text{k}\Omega$ | $f = 10\text{kHz}$ | 19 | | nV/ $\sqrt{\text{Hz}}$ |
| | | | $f = 1\text{MHz}$ | 16 | | |
| i_n | Input-Referred Current Noise | $R_F = 1\text{M}\Omega$ | $f = 10\text{kHz}$ | 1.35 | | pA/ $\sqrt{\text{Hz}}$ |
| | | | $f = 1\text{MHz}$ | 0.35 | | |
| THD | Total Harmonic Distortion | $f = 5\text{MHz}$, $V_O = 2V_{\text{PP}}$, $A_V = +2$ $R_L = 1\text{k}\Omega$ to $V^+/2$ | | -60 | | dBc |
| DG | Differential Gain | NTSC, $A_V = +2$ $R_L = 150\Omega$ to $V^+/2$ | | 0.12 | | % |
| DP | Differential Phase | NTSC, $A_V = +2$ $R_L = 150\Omega$ to $V^+/2$ | | 0.045 | | deg |
| T_S | Settling Time | $V_O = 2V_{\text{PP}}$, $\pm 0.1\%$ | | 33 | | ns |
| SR | Slew Rate | $A_V = -1$, (Note 8) | 130 | 172 | | V/ μs |
| V_{OS} | Input Offset Voltage | | | 1.02 | 5 7 | mV |

5V Electrical Characteristics (Continued)

Unless otherwise specified, all limits guaranteed for at $T_J = 25^\circ\text{C}$, $V^+ = 5\text{V}$, $V^- = 0\text{V}$, $V_O = V_{CM} = V^+/2$, and $R_L = 2\text{k}\Omega$ to $V^+/2$.

Boldface limits apply at the temperature extremes.

| Symbol | Parameter | Conditions | Min (Note 6) | Typ (Note 5) | Max (Note 6) | Units |
|---------------------|-------------------------------------|---|------------------|-----------------|----------------------|------------------------------|
| TC V_{OS} | Input Offset Average Drift | (Note 11) | | 8 | | $\mu\text{V}/^\circ\text{C}$ |
| I_B | Input Bias Current | (Note 7) | | -1.2 | -2.6 -3.25 | μA |
| I_{OS} | Input Offset Current | | | 20 | 800 1000 | nA |
| R_{IN} | Common Mode Input Resistance | $A_V = +1$, $f = 1\text{kHz}$, $R_S = 1\text{M}\Omega$ | | 6.88 | | $\text{M}\Omega$ |
| C_{IN} | Common Mode Input Capacitance | $A_V = +1$, $R_S = 100\text{k}\Omega$ | | 1.32 | | pF |
| CMVR | Common-Mode Input Voltage Range | CMRR $\geq 50\text{dB}$ | | -0.3 | -0.2 -0.1 | V |
| | | | | 4 | 3.8 3.6 | |
| CMRR | Common Mode Rejection Ratio | (Note 12) | 72 | 95 | | dB |
| A_{VOL} | Large Signal Voltage Gain | $V_O = 4V_{PP}$ $R_L = 2\text{k}\Omega$ to $V^+/2$ | 86 82 | 100 | | dB |
| | | $V_O = 3.75V_{PP}$ $R_L = 150\Omega$ to $V^+/2$ | 74 70 | 77 | | |
| | | | | | | |
| V_O | Output Swing High | $R_L = 2\text{k}\Omega$ to $V^+/2$, $V_{ID} = 200\text{mV}$ | 4.90 | 4.97 | | V |
| | | $R_L = 150\Omega$ to $V^+/2$, $V_{ID} = 200\text{mV}$ | 4.65 | 4.90 | | |
| | | $R_L = 50\Omega$ to $V^+/2$, $V_{ID} = 200\text{mV}$ | 4.40 | 4.77 | | |
| | Output Swing Low | $R_L = 2\text{k}\Omega$ to $V^+/2$, $V_{ID} = -200\text{mV}$ | | 25 | 100 | mV |
| | | $R_L = 150\Omega$ to $V^+/2$, $V_{ID} = -200\text{mV}$ | | 85 | 200 | |
| | | $R_L = 50\Omega$ to $V^+/2$, $V_{ID} = -200\text{mV}$ | | 190 | 400 | |
| I_{SC} | Output Short Circuit Current | Sourcing to $V^+/2$, (Note 10) | 100 79 | 160 | | mA |
| | | Sinking from $V^+/2$, (Note 10) | 120 85 | 190 | | |
| I_{OUT} | Output Current | $V_O = 0.5\text{V}$ from either supply | | 110 | | mA |
| PSRR | Power Supply Rejection Ratio | (Note 12) | 72 | 96 | | dB |
| I_S | Supply Current (Enabled) | No Load | | 3.6 | 5.8 8.0 | mA |
| | Supply Current (Disabled) | | | 0.40 | 0.8 1.0 | |
| TH_SD | Threshold Voltage for Shutdown Mode | | | $V^+ - 1.65$ | | V |
| $I_{SD\text{ PIN}}$ | Shutdown Pin Input Current | SD Pin Connected to 0V (Note 7) | | -30 | | μA |
| T_{ON} | On Time after Shutdown | | | 83 | | nsec |
| T_{OFF} | Off Time to Shutdown | | | 160 | | nsec |
| R_{OUT} | Output Resistance Closed Loop | $R_F = 10\text{k}\Omega$, $f = 1\text{kHz}$, $A_V = -1$ | | 29 | | m Ω |
| | | $R_F = 10\text{k}\Omega$, $f = 1\text{MHz}$, $A_V = -1$ | | 253 | | |

±5V Electrical Characteristics

Unless otherwise specified, all limits guaranteed for at $T_J = 25^\circ\text{C}$, $V_{\text{SUPPLY}} = \pm 5\text{V}$, $V_O = V_{\text{CM}} = \text{GND}$, and $R_L = 2\text{k}\Omega$ to $V^+/2$. **Boldface** limits apply at the temperature extremes.

| Symbol | Parameter | Conditions | Min (Note 6) | Typ (Note 5) | Max (Note 6) | Units |
|---------------------|---------------------------------|--|--------------------|-----------------|-----------------|------------------------------|
| BW | -3dB BW | $A_V = +1$ | 150 | 228 | | MHz |
| | | $A_V = -1$ | | 65 | | |
| $BW_{0.1\text{dB}}$ | 0.1dB Gain Flatness | $R_F = 2.26\text{k}\Omega$, $R_L = 1\text{k}\Omega$ | | 18 | | MHz |
| FPBW | Full Power Bandwidth | $A_V = +1$, $V_{\text{OUT}} = 2V_{\text{PP}}$, -1dB | | 29 | | MHz |
| GBW | Gain Bandwidth Product | $A_V = +1$ | | 90 | | MHz |
| e_n | Input-Referred Voltage Noise | $R_F = 33\text{k}\Omega$ | $f = 10\text{kHz}$ | 19 | | $\text{nV}/\sqrt{\text{Hz}}$ |
| | | | $f = 1\text{MHz}$ | 16 | | |
| i_n | Input-Referred Current Noise | $R_F = 1\text{M}\Omega$ | $f = 10\text{kHz}$ | 1.13 | | $\text{pA}/\sqrt{\text{Hz}}$ |
| | | | $f = 1\text{MHz}$ | 0.34 | | |
| THD | Total Harmonic Distortion | $f = 5\text{MHz}$, $V_O = 2V_{\text{PP}}$, $A_V = +2$, $R_L = 1\text{k}\Omega$ | | -71.2 | | dBc |
| DG | Differential Gain | NTSC, $A_V = +2$ $R_L = 150\Omega$ | | 0.11 | | % |
| DP | Differential Phase | NTSC, $A_V = +2$ $R_L = 150\Omega$ | | 0.053 | | deg |
| T_S | Settling Time | $V_O = 2V_{\text{PP}}$, $\pm 0.1\%$ | | 33 | | ns |
| SR | Slew Rate | $A_V = -1$ (Note 8) | 140 | 200 | | $\text{V}/\mu\text{s}$ |
| V_{OS} | Input Offset Voltage | | | 1.03 | 5 7 | mV |
| TC V_{OS} | Input Offset Voltage Drift | (Note 11) | | 8 | | $\mu\text{V}/^\circ\text{C}$ |
| I_B | Input Bias Current | (Note 7) | | -1.40 | -2.6 -3.25 | μA |
| I_{OS} | Input Offset Current | | | 20 | 800 1000 | nA |
| R_{IN} | Common Mode Input Resistance | $A_V + 1$, $f = 1\text{kHz}$, $R_S = 1\text{M}\Omega$ | | 7.5 | | $\text{M}\Omega$ |
| C_{IN} | Common Mode Input Capacitance | $A_V = +1$, $R_S = 100\text{k}\Omega$ | | 1.28 | | pF |
| CMVR | Common Mode Input Voltage Range | CMRR $\geq 50\text{dB}$ | | -5.3 | -5.2 -5.1 | V |
| | | | 3.8 3.6 | 4.0 | | |
| CMRR | Common Mode Rejection Ratio | (Note 12) | 72 | 95 | | dB |
| A_{VOL} | Large Signal Voltage Gain | $V_O = 9V_{\text{PP}}$, $R_L = 2\text{k}\Omega$ | 88 84 | 100 | | dB |
| | | $V_O = 8V_{\text{PP}}$, $R_L = 150\Omega$ | 74 70 | 77 | | |
| V_O | Output Swing High | $R_L = 2\text{k}\Omega$, $V_{\text{ID}} = 200\text{mV}$ | 4.85 | 4.96 | | V |
| | | $R_L = 150\Omega$, $V_{\text{ID}} = 200\text{mV}$ | 4.55 | 4.80 | | |
| | | $R_L = 50\Omega$, $V_{\text{ID}} = 200\text{mV}$ | 3.60 | 4.55 | | |
| | Output Swing Low | $R_L = 2\text{k}\Omega$, $V_{\text{ID}} = -200\text{mV}$ | | -4.97 | -4.90 | V |
| | | $R_L = 150\Omega$, $V_{\text{ID}} = -200\text{mV}$ | | -4.85 | -4.55 | |
| | | $R_L = 50\Omega$, $V_{\text{ID}} = -200\text{mV}$ | | -4.65 | -4.30 | |
| I_{SC} | Output Short Circuit Current | Sourcing to Ground, (Note 10) | 100 80 | 168 | | mA |
| | | Sinking to Ground, (Note 10) | 110 85 | 190 | | |

±5V Electrical Characteristics (Continued)

Unless otherwise specified, all limits guaranteed for at $T_J = 25^\circ\text{C}$, $V_{\text{SUPPLY}} = \pm 5\text{V}$, $V_O = V_{\text{CM}} = \text{GND}$, and $R_L = 2\text{k}\Omega$ to $V^+/2$. **Boldface** limits apply at the temperature extremes.

| Symbol | Parameter | Conditions | Min (Note 6) | Typ (Note 5) | Max (Note 6) | Units |
|---------------------|-------------------------------------|---|-----------------|-----------------|-----------------|---------------|
| I_{OUT} | Output Current | $V_O = 0.5\text{V}$ from either supply | | 112 | | mA |
| PSRR | Power Supply Rejection Ratio | (Note 12) | 72 | 96 | | dB |
| I_S | Supply Current (Enabled) | No Load | | 4.18 | 6.5 | mA |
| | Supply Current (Disabled) | | | 0.758 | 1.0 | |
| TH_SD | Threshold Voltage for Shutdown Mode | | | $V^+ - 1.67$ | | V |
| $I_{\text{SD PIN}}$ | Shutdown Pin Input Current | SD Pin Connected to -5V (Note 7) | | -84 | | μA |
| T_{ON} | On Time after Shutdown | | | 83 | | nsec |
| T_{OFF} | Off Time to Shutdown | | | 160 | | nsec |
| R_{OUT} | Output Resistance Closed Loop | $R_F = 10\text{k}\Omega$, $f = 1\text{kHz}$, $A_V = -1$ | | 32 | | m Ω |
| | | $R_F = 10\text{k}\Omega$, $f = 1\text{MHz}$, $A_V = -1$ | | 226 | | |

Note 1: Absolute Maximum Ratings indicate limits beyond which damage to the device may occur. Operating Ratings indicate conditions for which the device is intended to be functional, but specific performance is not guaranteed. For guaranteed specifications and the test conditions, see the Electrical Characteristics.

Note 2: Human body model, $1.5\text{k}\Omega$ in series with 100pF .

Note 3: Applies to both single-supply and split-supply operation. Continuous short circuit operation at elevated ambient temperature can result in exceeding the maximum allowed junction temperature of 150°C .

Note 4: The maximum power dissipation is a function of $T_{\text{J(MAX)}}$, θ_{JA} , and T_A . The maximum allowable power dissipation at any ambient temperature is $P_D = (T_{\text{J(MAX)}} - T_A) / \theta_{\text{JA}}$. All numbers apply for packages soldered directly onto a PC board.

Note 5: Typical values represent the most likely parametric norm.

Note 6: All limits are guaranteed by testing or statistical analysis.

Note 7: Positive current corresponds to current flowing into the device.

Note 8: Slew rate is the average of the rising and falling slew rates.

Note 9: Machine Model, 0Ω in series with 200pF .

Note 10: Short circuit test is a momentary test.

Note 11: Offset voltage average drift determined by dividing the change in V_{OS} at temperature extremes into the total temperature change.

Note 12: $f \leq 1\text{kHz}$ (see typical performance Characteristics)

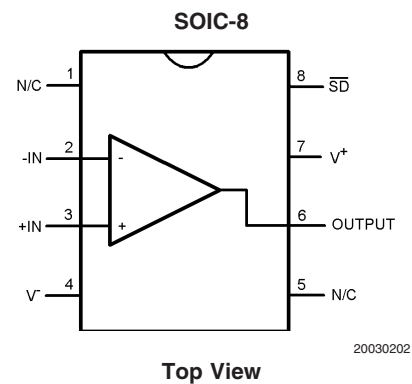
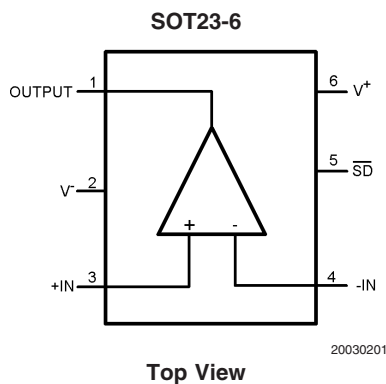
Connection Diagrams**Ordering Information**

| Package | Part Number | Package Marking | Transport Media | NSC Drawing |
|--------------|-------------|-----------------|--------------------------|-------------|
| 6-Pin SOT-23 | LMH6639MF | A81A | 1k Units Tape and Reel | MF06A |
| | LMH6639MFX | | 3k Units Tape and Reel | |
| 8-Pin SOIC | LMH6639MA | LMH6639MA | Rails | M08A |
| | LMH6639MAX | | 2.5k Units Tape and Reel | |

Typical Performance Characteristics

At $T_J = 25^\circ\text{C}$, $V^+ = +2.5\text{V}$, $V^- = -2.5\text{V}$, $R_F = 330\Omega$ for $A_V = +2$, $R_F = 1\text{k}\Omega$ for $A_V = -1$. Unless otherwise specified.

Output Sinking Saturation Voltage vs. I_{OUT} for Various Temperature

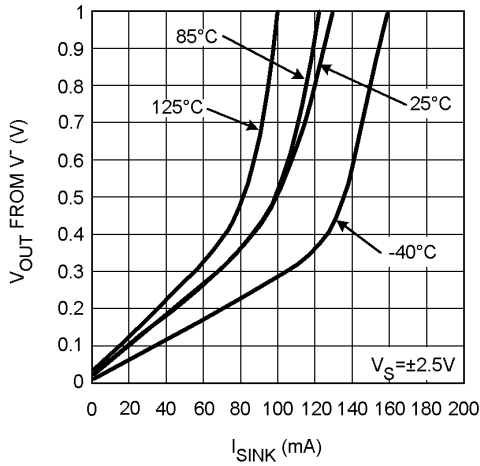

20030239

Output Sourcing Saturation Voltage vs. I_{OUT} for Various Temperature

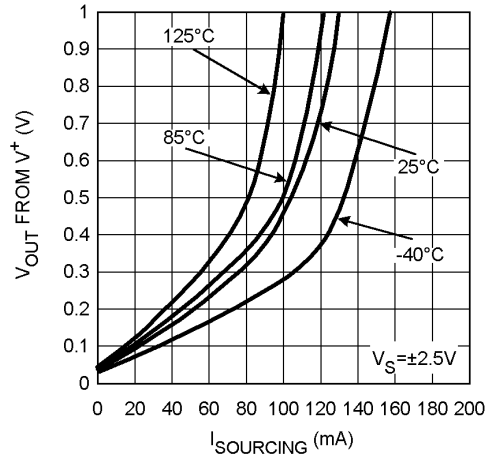

20030237

Positive Output Saturation Voltage vs. V_{SUPPLY} for Various Temperature

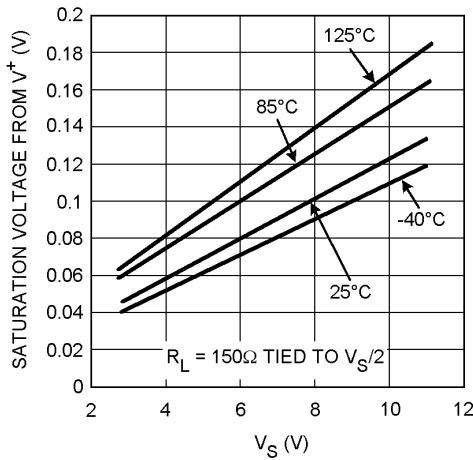

20030233

Negative Output Saturation Voltage vs. V_{SUPPLY} for Various Temperature

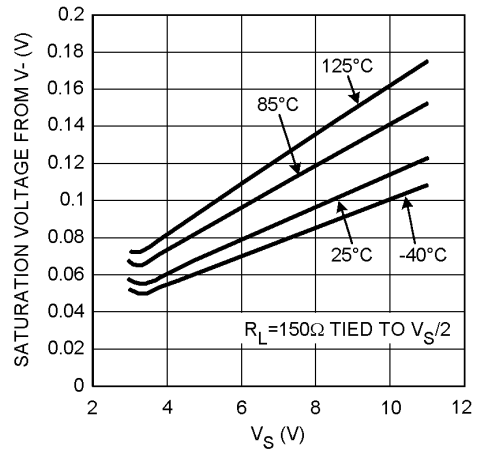

20030234

V_{OUT} from V^+ vs. I_{SOURCE}

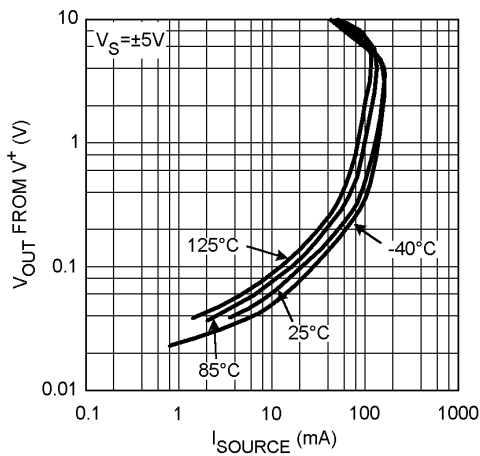

20030238

V_{OUT} from V^- vs. I_{SINK}

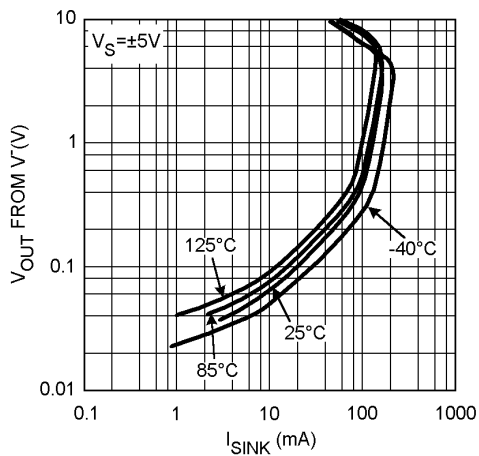

20030236

Typical Performance Characteristics At $T_J = 25^\circ\text{C}$, $V^+ = +2.5$, $V^- = -2.5\text{V}$, $R_F = 330\Omega$ for $A_V = +2$, $R_F = 1\text{k}\Omega$ for $A_V = -1$. Unless otherwise specified. (Continued)

I_{OS} vs. V_S for Various Temperature

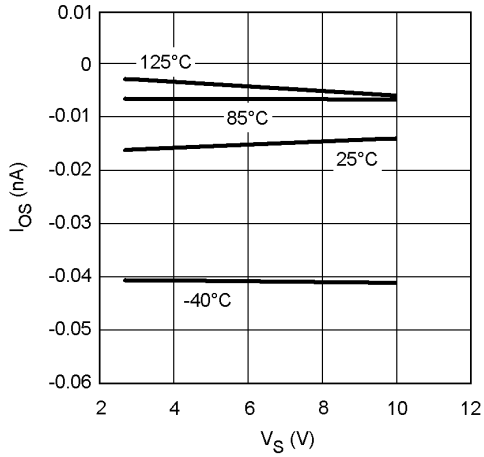

20030232

V_{OS} vs. V_S for 3 Representative Units

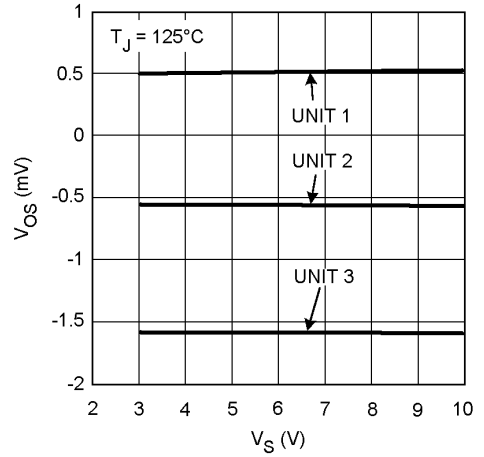

20030245

V_{OS} vs. V_S for 3 Representative Units

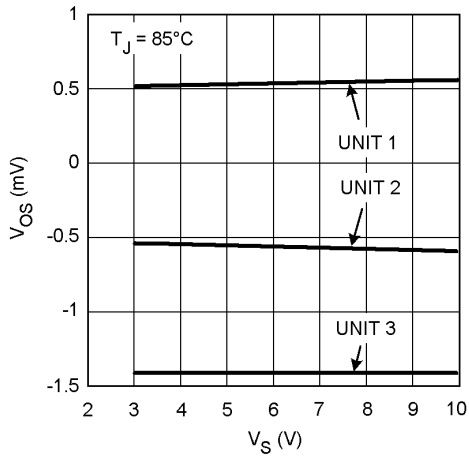

20030244

V_{OS} vs. V_S for 3 Representative Units

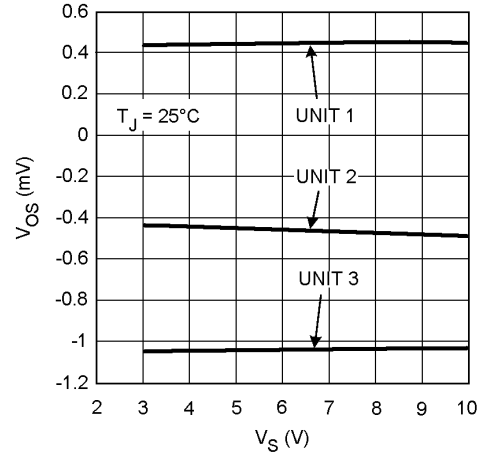

20030243

V_{OS} vs. V_S for 3 Representative Units

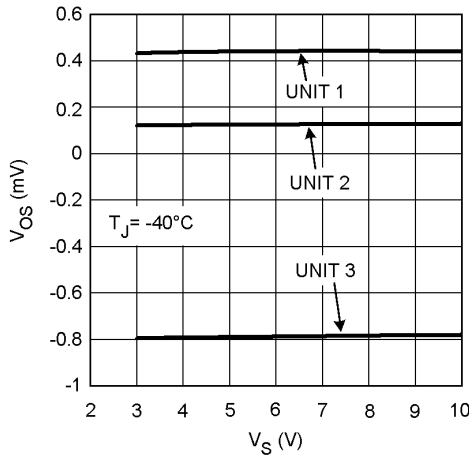

20030242

I_{SUPPLY} vs. V_{CM} for Various Temperature

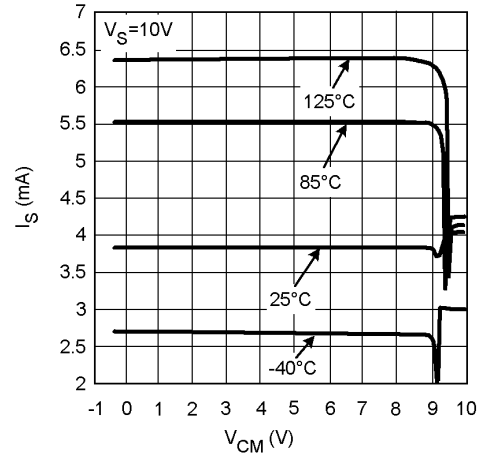

20030240

Typical Performance Characteristics At $T_J = 25^\circ\text{C}$, $V^+ = +2.5$, $V^- = -2.5\text{V}$, $R_F = 330\Omega$ for $A_V = +2$, $R_F = 1\text{k}\Omega$ for $A_V = -1$. Unless otherwise specified. (Continued)

I_{SUPPLY} vs. V_S for Various Temperature

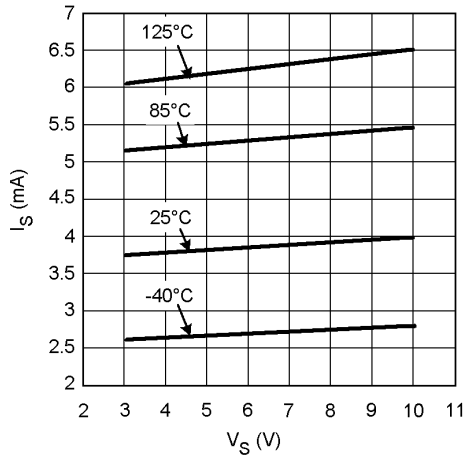

20030241

I_B vs. V_S for Various Temperature

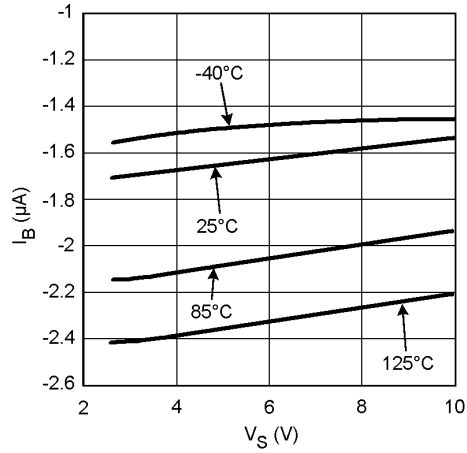

20030235

Bandwidth for Various V_S

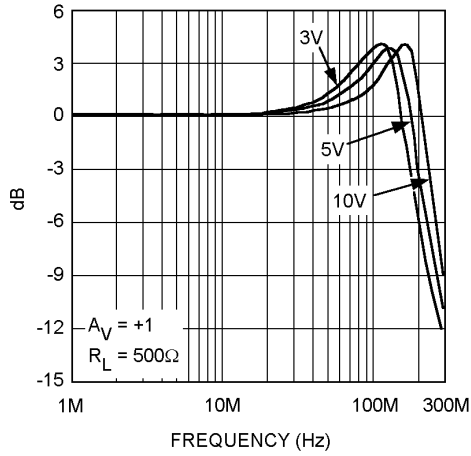

20030206

Bandwidth for Various V_S

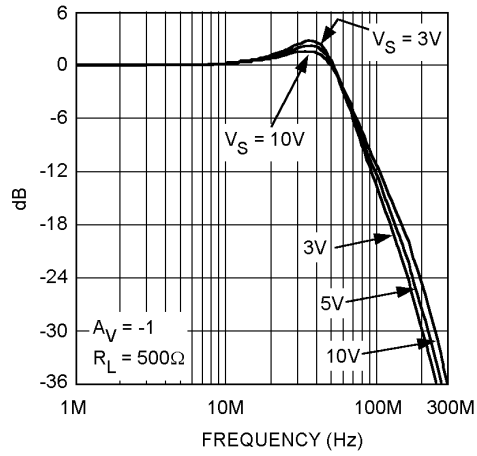

20030205

Gain vs. Frequency Normalized

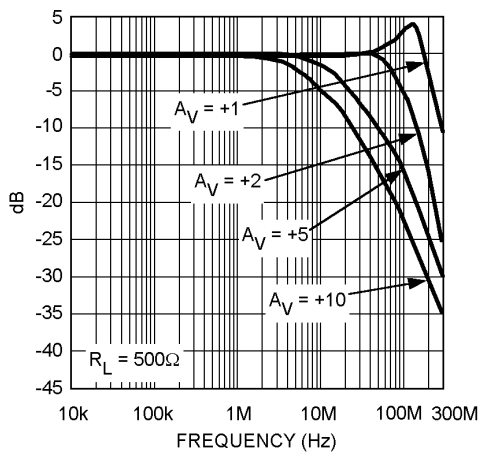

20030207

Gain vs. Frequency Normalized

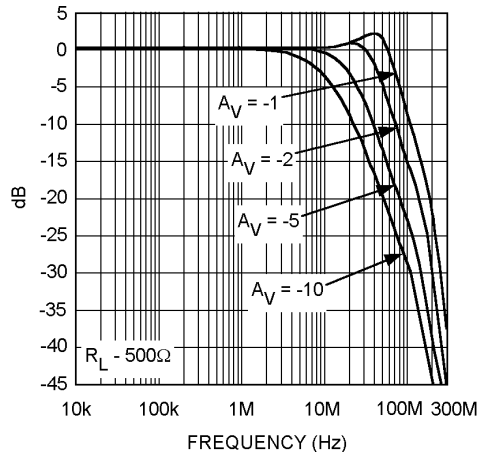

20030208

Typical Performance Characteristics At $T_J = 25^\circ\text{C}$, $V^+ = +2.5$, $V^- = -2.5$, $R_F = 330\Omega$ for $A_V = +2$, $R_F = 1\text{k}\Omega$ for $A_V = -1$. Unless otherwise specified. (Continued)

0.1dB Gain Flatness

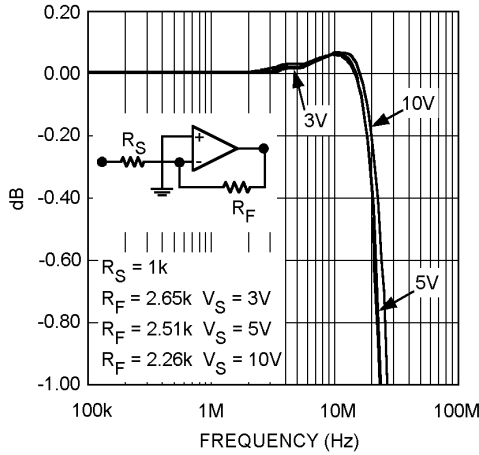

20030209

Gain and phase vs. Frequency for Various Temperature

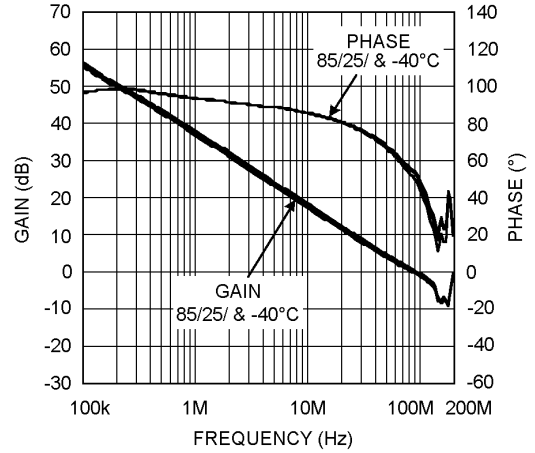

20030204

Frequency Response vs. Temperature

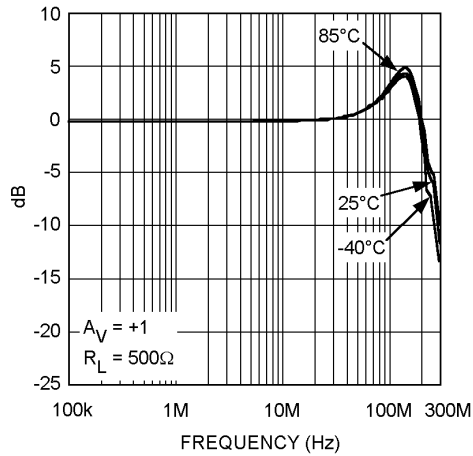

20030210

Harmonic Distortion

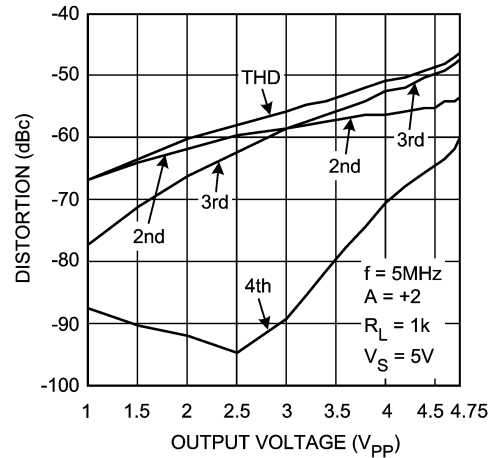

20030269

Differential Gain/Phase

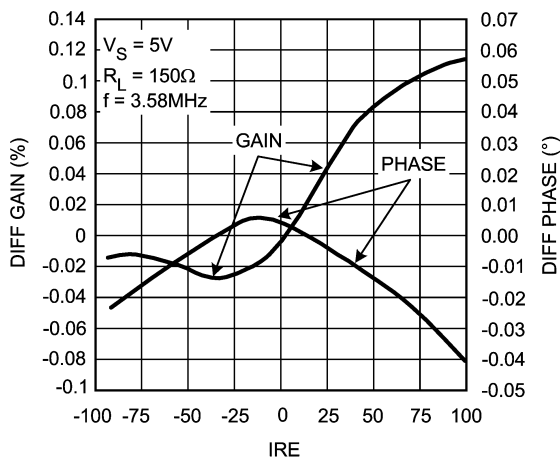

20030270

On-Off Switching DC Voltage

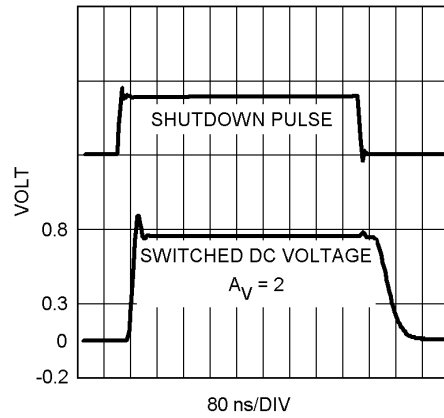

20030211

Typical Performance Characteristics At $T_J = 25^\circ\text{C}$, $V^+ = +2.5$, $V^- = -2.5\text{V}$, $R_F = 330\Omega$ for $A_V = +2$, $R_F = 1\text{k}\Omega$ for $A_V = -1$. Unless otherwise specified. (Continued)

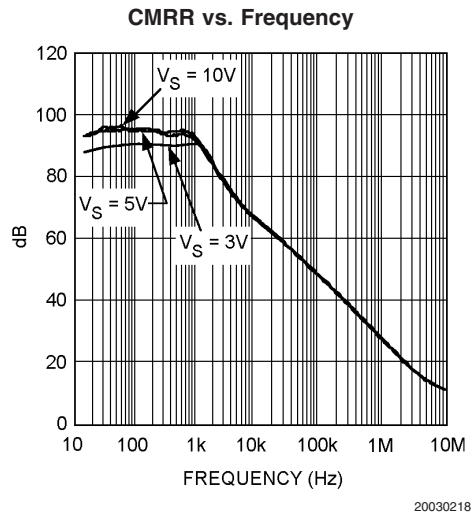
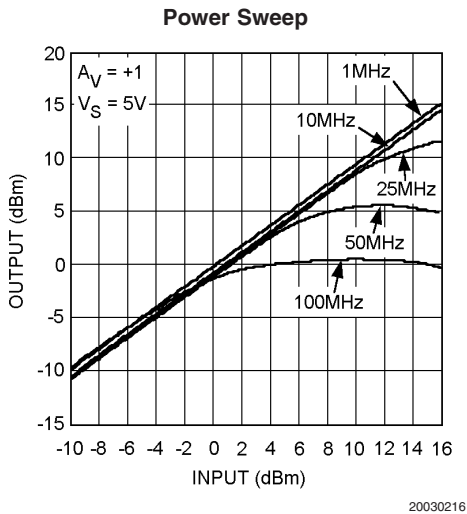
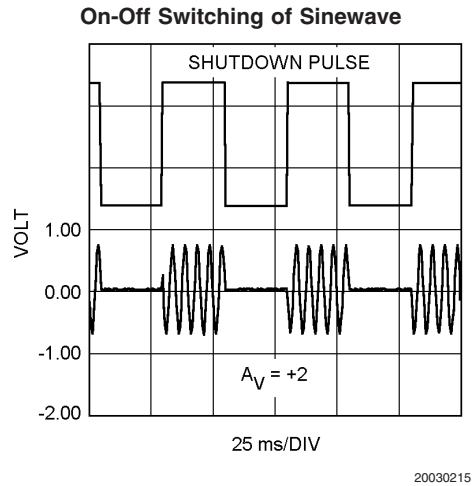
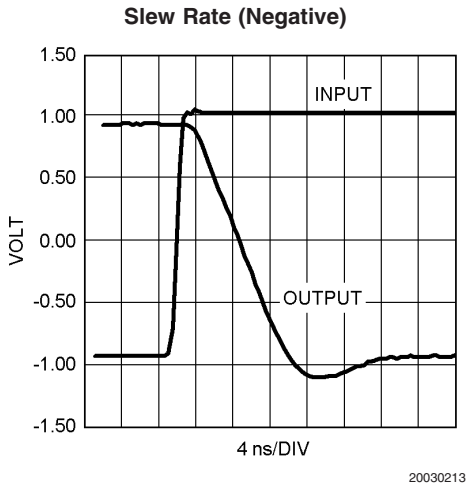
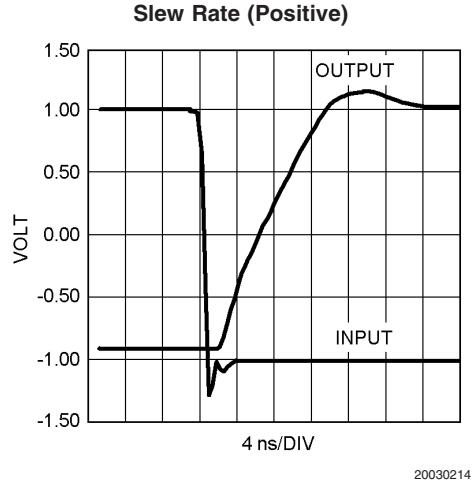
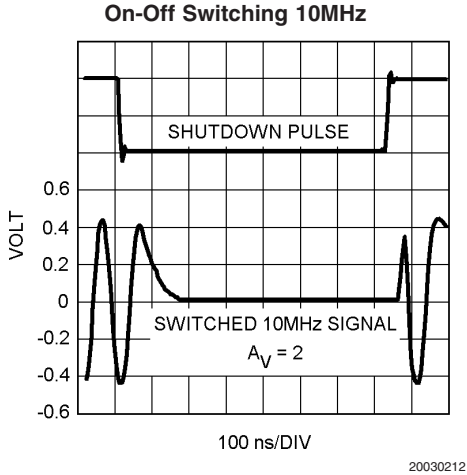

Typical Performance Characteristics At $T_J = 25^\circ\text{C}$, $V^+ = +2.5$, $V^- = -2.5$, $R_F = 330\Omega$ for $A_V = +2$, $R_F = 1\text{k}\Omega$ for $A_V = -1$. Unless otherwise specified. (Continued)

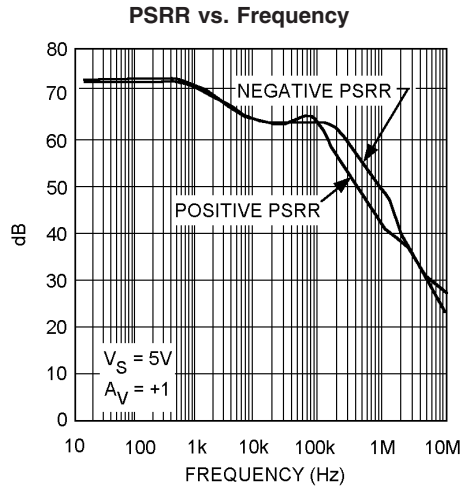

20030217

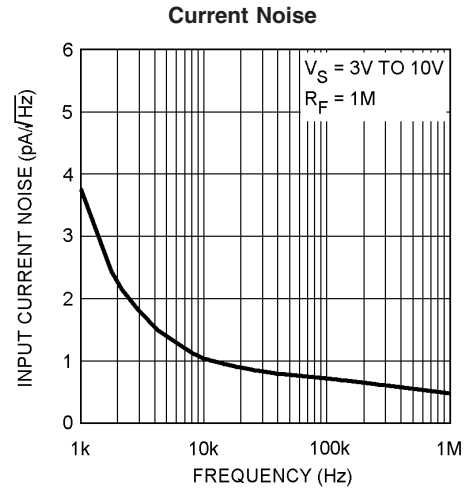

20030220

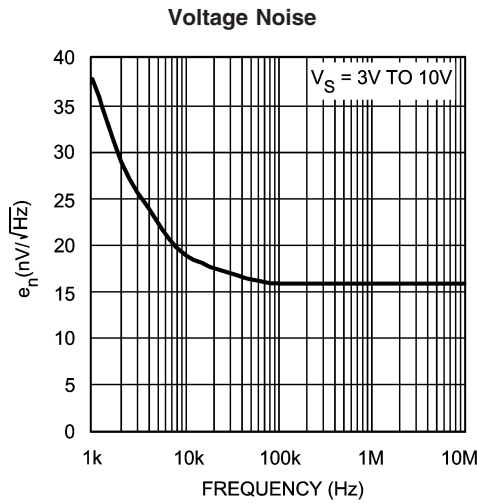

20030219

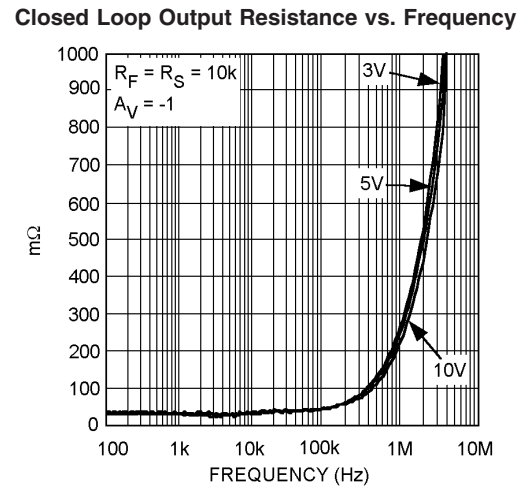

20030221

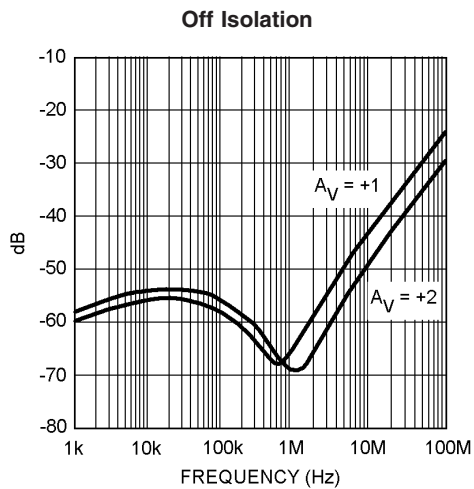

20030222

Small Signal Pulse Response ($A_V = +1$, $R_L = 2\text{k}$)

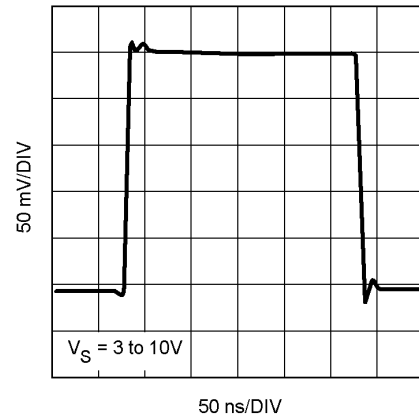

20030250

Typical Performance Characteristics At $T_J = 25^\circ\text{C}$, $V^+ = +2.5$, $V^- = -2.5\text{V}$, $R_F = 330\Omega$ for $A_V = +2$, $R_F = 1\text{k}\Omega$ for $A_V = -1$. Unless otherwise specified. (Continued)

Small Signal Pulse Response ($A_V = -1$)

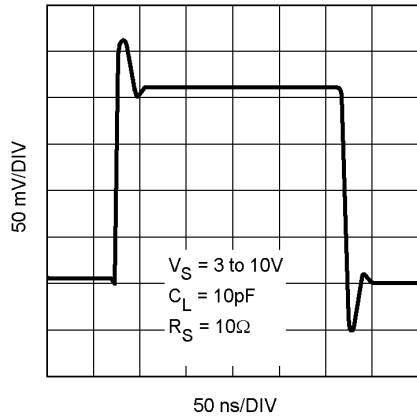

20030249

Large Signal Pulse Response ($R_L = 2\text{k}$)

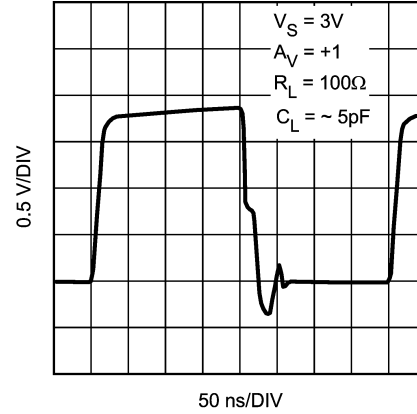

20030226

Large Signal Pulse Response

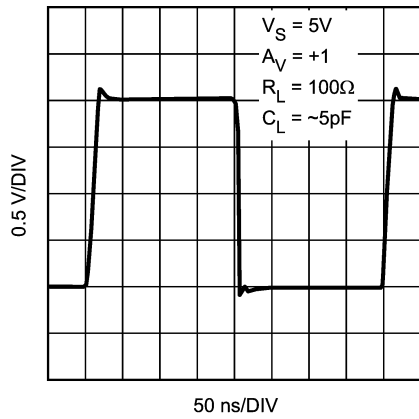

20030227

Large Signal Pulse Response

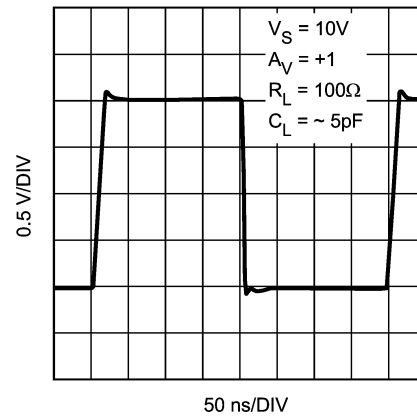

20030228

Application Notes

MULTIPLEXING 5 AND 10MHz

The LMH6639 may be used to implement a circuit which multiplexes two signals of different frequencies. Three LMH6639 high speed op-amps are used in the circuit of *Figure 2* to accomplish the multiplexing function. Two LMH6639 are used to provide gain for the input signals, and the third device is used to provide output gain for the selected signal.

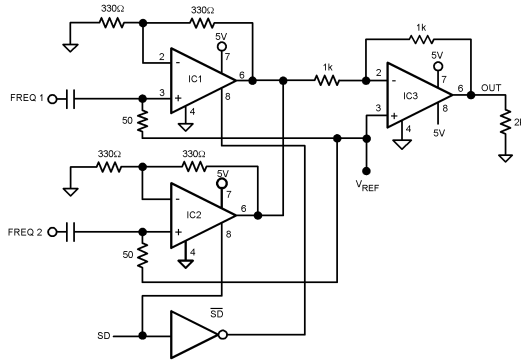

Note: Pin numbers pertain to SOIC-8 package

20030247

FIGURE 2. Multiplexer

Multiplexing signals “FREQ 1” and “FREQ 2” exhibit closed loop non-inverting gain of +2 each based upon identical 330Ω resistors in the gain setting positions of IC1 and IC2. The two multiplexing signals are combined at the input of IC3, which is the third LMH6639. This amplifier may be used as a unity gain buffer or may be used to set a particular gain for the circuit.

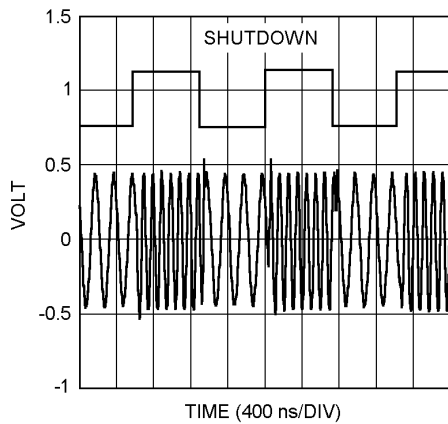

20030248

FIGURE 3. Switching between 5 and 10MHz

1k resistors are used to set an inverting gain of -1 for IC3 in the circuit of *Figure 2*. *Figure 3* illustrates the waveforms produced. The upper trace shows the switching waveform used to switch between the 5MHz and 10MHz multiplex signals. The lower trace shows the output waveform consisting of 5MHz and 10MHz signals corresponding to the high or low state of the switching signal.

In the circuit of *Figure 2*, the outputs of IC1 and IC2 are tied together such that their output impedances are placed in parallel at the input of IC3. The output impedance of the disabled amplifier is high compared both to the output impedance of the active amplifier and the 330Ω gain setting resistors. The closed loop output resistance for the LMH6639 is around 0.2Ω. Thus the active state amplifier output impedance dominates the input node to IC3, while the disabled amplifier is assured of a high level of suppression of unwanted signals which might be present at the output.

SHUTDOWN OPERATION

With \overline{SD} pin left floating, the device enters normal operation. However, since the \overline{SD} pin has high input impedance, it is best tied to V^+ for normal operation. This will avoid inadvertent shutdown due to capacitive pick-up from nearby nodes. LMH6639 will typically go into shutdown when \overline{SD} pin is more than 1.7V below V^+ , regardless of operating supplies. The \overline{SD} pin can be driven by push-pull or open collector (open drain) output logic. Because the LMH6639’s shutdown is referenced to V^+ , interfacing to the shutdown logic is rather simple, for both single and dual supply operation, with either form of logic used. Typical configurations are shown in *Figure 4* and *Figure 5* below for push-pull output:

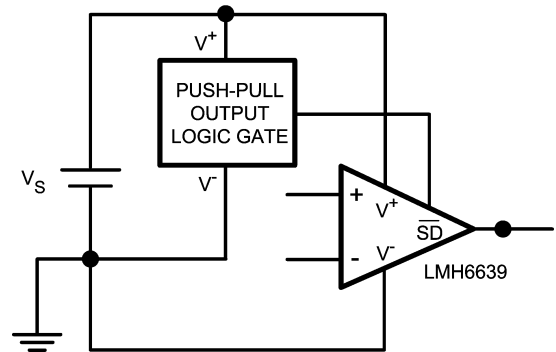

20030271

FIGURE 4. Shutdown Interface (Single Supply)

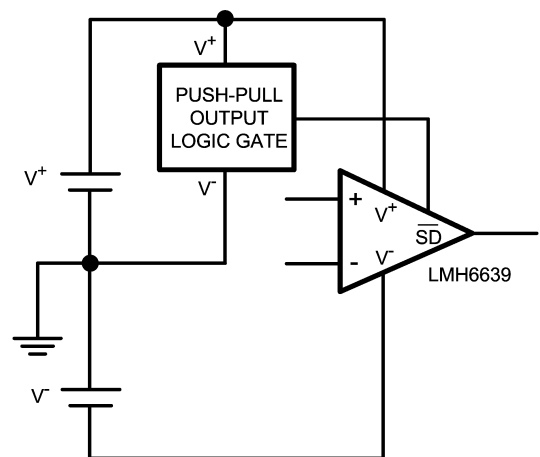

20030272

FIGURE 5. Shutdown Interface (Dual Supplies)

Common voltages for logic gates are +5V or +3V. To ensure proper power on/off with these supplies, the logic should be able to swing to 3.4V and 1.4V minimum, respectively.

Application Notes (Continued)

LMH6639's shutdown pin can also be easily controlled in applications where the analog and digital sections are operated at different supplies. *Figure 6* shows a configuration where a logic output, SD, can turn the LMH6639 on and off, independent of what supplies are used for the analog and the digital sections:

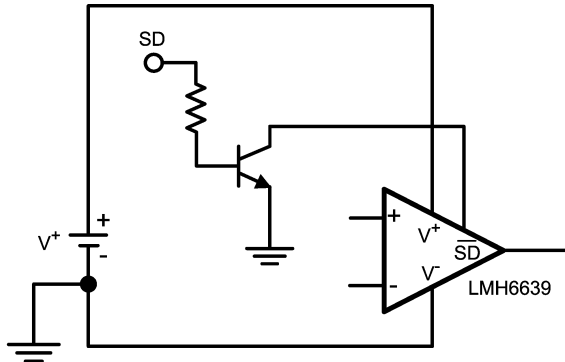

20030273

FIGURE 6. Shutdown Interface (Single Supply, Open Collector Logic)

The LMH6639 has an internal pull-up resistor on \overline{SD} such that if left un-connected, the device will be in normal operation. Therefore, no pull-up resistor is needed on this pin. Another common application is where the transistor in *Figure 6* above, would be internal to an open collector (open drain) logic gate; the basic connections will remain the same as shown.

PCB LAYOUT CONSIDERATION AND COMPONENTS SELECTION

Care should be taken while placing components on a PCB. All standard rules should be followed especially the ones for high frequency and/ or high gain designs. Input and output pins should be separated to reduce cross-talk, especially under high gain conditions. A groundplane will be helpful to avoid oscillations. In addition, a ground plane can be used to create micro-strip transmission lines for matching purposes. Power supply, as well as shutdown pin de-coupling will reduce cross-talk and chances of oscillations.

Another important parameter in working with high speed amplifiers is the component values selection. Choosing high value resistances reduces the cut-off frequency because of the influence of parasitic capacitances. On the other hand choosing the resistor values too low could "load down" the nodes and will contribute to higher overall power dissipation. Keeping resistor values at several hundreds of ohms up to several k Ω will offer good performance.

National Semiconductor suggests the following evaluation boards as a guide for high frequency layout and as an aid in device testing and characterization:

| Device | Package | Evaluation Board PN |
|-----------|------------|---------------------|
| LMH6639MA | 8-Pin SOIC | CLC730027 |
| LMH6639MF | SOT23-6 | CLC730116 |

These free evaluation boards are shipped when a device sample request is placed with National Semiconductor. For normal operation, tie the SD pin to V+.

Physical Dimensions inches (millimeters) unless otherwise noted

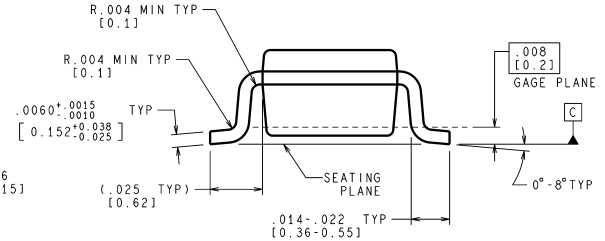
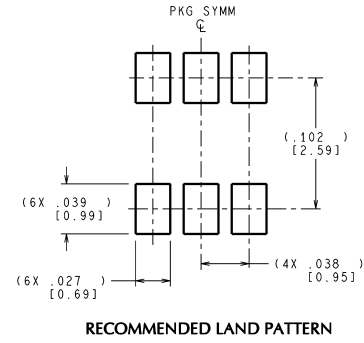
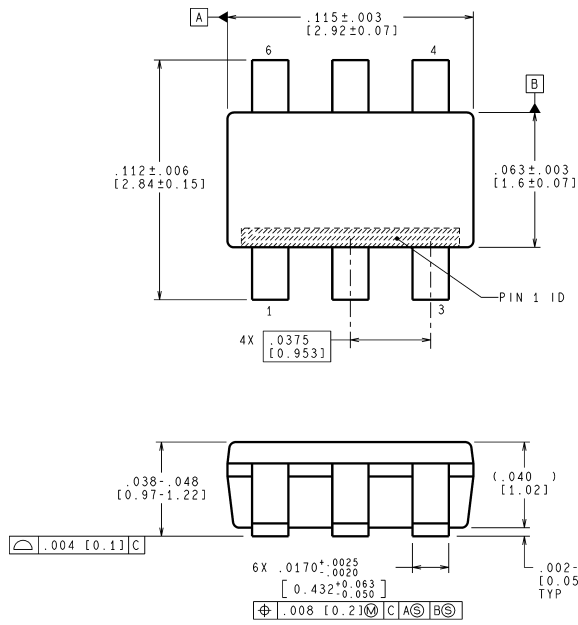

CONTROLLING DIMENSION IS INCH
VALUES IN [] ARE MILLIMETERS

MF06A (Rev B)

6-Pin SOT23
NS Package Number MF06A

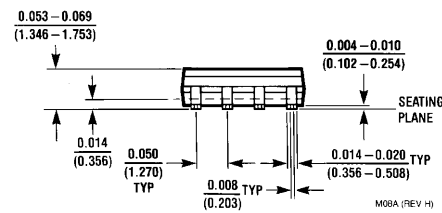
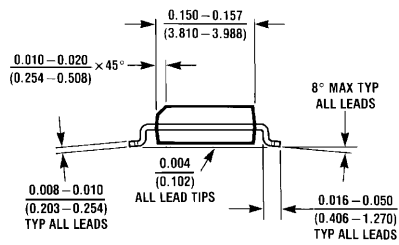
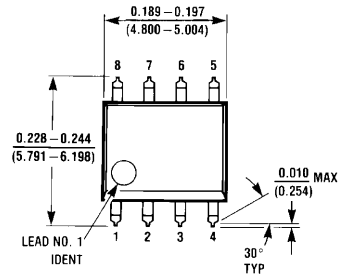

8-Pin SOIC
NS Package Number M08A

M08A (REV H)

Notes

National does not assume any responsibility for use of any circuitry described, no circuit patent licenses are implied and National reserves the right at any time without notice to change said circuitry and specifications.

For the most current product information visit us at www.national.com.

LIFE SUPPORT POLICY

NATIONAL'S PRODUCTS ARE NOT AUTHORIZED FOR USE AS CRITICAL COMPONENTS IN LIFE SUPPORT DEVICES OR SYSTEMS WITHOUT THE EXPRESS WRITTEN APPROVAL OF THE PRESIDENT AND GENERAL COUNSEL OF NATIONAL SEMICONDUCTOR CORPORATION. As used herein:

1. Life support devices or systems are devices or systems which, (a) are intended for surgical implant into the body, or (b) support or sustain life, and whose failure to perform when properly used in accordance with instructions for use provided in the labeling, can be reasonably expected to result in a significant injury to the user.
2. A critical component is any component of a life support device or system whose failure to perform can be reasonably expected to cause the failure of the life support device or system, or to affect its safety or effectiveness.

BANNED SUBSTANCE COMPLIANCE

National Semiconductor certifies that the products and packing materials meet the provisions of the Customer Products Stewardship Specification (CSP-9-111C2) and the Banned Substances and Materials of Interest Specification (CSP-9-111S2) and contain no "Banned Substances" as defined in CSP-9-111S2.



National Semiconductor
Americas Customer
Support Center
 Email: new.feedback@nsc.com
 Tel: 1-800-272-9959

National Semiconductor
Europe Customer Support Center
 Fax: +49 (0) 180-530 85 86
 Email: europe.support@nsc.com
 Deutsch Tel: +49 (0) 69 9508 6208
 English Tel: +44 (0) 870 24 0 2171
 Français Tel: +33 (0) 1 41 91 8790

National Semiconductor
Asia Pacific Customer
Support Center
 Email: ap.support@nsc.com

National Semiconductor
Japan Customer Support Center
 Fax: 81-3-5639-7507
 Email: jpn.feedback@nsc.com
 Tel: 81-3-5639-7560